



Automatic Transfer Switch (ATS)
Manual Instruction
YES1 series GA model

**SHANGHAI
YUHUANG ELECTRICAL CO.,LTD**

ADD:NO.1576 Shenzhuan Road,Zhujiajiao Town,
Qingpu District, Shanghai
TEL:+86-21-51097231
FAX:+86-21-51097235
<http://www.chinayuye.com>

Suggest send the instruction to final user

**SHANGHAI
YUHUANG ELECTRICAL
CO.,LTD**

Contents Index

1.Types and meanings	03
2.Main technology parameters	03
3.Products structure instructio	04
4.Outline overall and installing dimensions	05
5.Usage method	08
6.Connection terminal using method	11
7.Correct installation method for switch	12
8.Wiring method of switch	12
9.Debug indication	13

Notice:

Before you operate this Automatic transfer switch (hereinafter ATS), please read and understand these instructions carefully.

Dangerous

- ▲ Before you install or operate the ATS, please read and understand these instructions carefully. Only the professional ATS personnel can carry out this installation, adjustment, repair and maintenance.
- ▲ Many parts of the ATS, including printed circuit boards, when it work on-line voltage, cannot touch these parts. Use insulated tools only.
- ▲ Do not touch the components which not protected.
- ▲ Before maintenance the line of ATS, we should take the following preventive measures:
 - Disconnect all power.
 - Put a "prohibited closing" signs before the locate of the switch
 - Switch to "0" position and then hang padlock.

Warning

Inconsistent with the line voltage:
Before Power and configuration for the ATS , we must ensure the line voltage is in the scope of the power supply voltage in the name plate of the ATS If the line voltage and power supply voltage range is different ,it will damage the ATS. Using it not according to the instructions it will damage the equipment.

Check and install

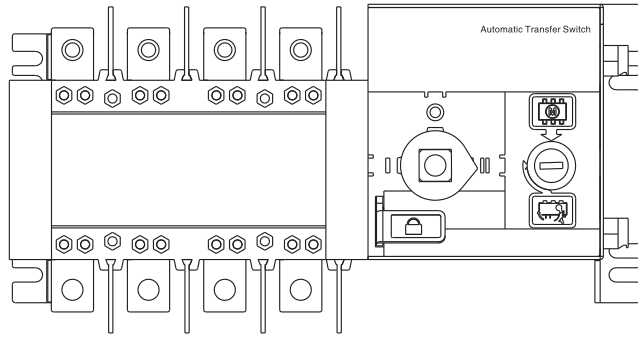

Picture 1

- **ATS delivery**
Check and make sure the product is the ordering products.
- **Check the voltage**
Check and make sure the voltage and the working voltage of the ATS.
Whether it is in the scope of the voltage.
- **Install the ATS**
Install the ATS according this manual instruction.
Install all the external accessories.
- **Wiring the ATS**
Connect the bus bar of the switch which coincided with the rated current.
Connect the control wire and outside indication well according to the manual instruction.

1.Type and meaning

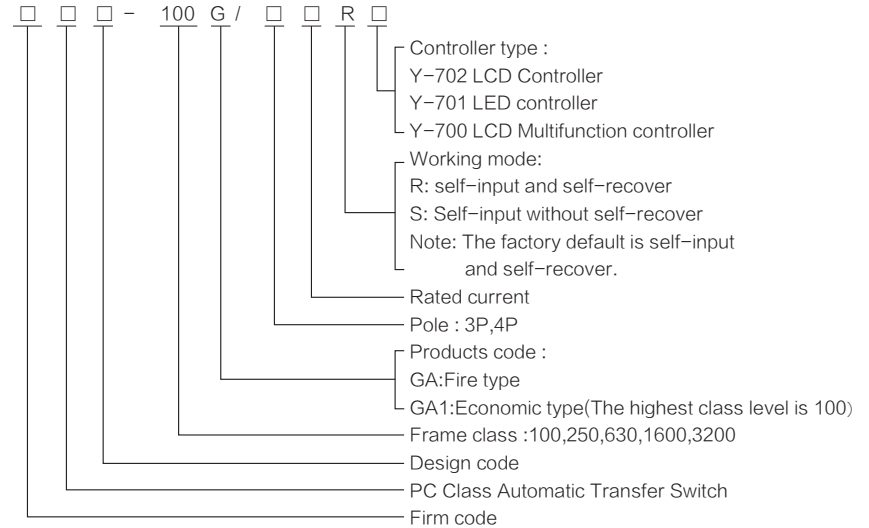

2.Main technology parameters

Frame class	100							250			1600			3200															
Agreed heating current Ith(A)	63							100			160~3200																		
Rated current In(A)	16	20	25	32	40	50	63	80	100	125	160	250	400	630	800	1000	1250	1600	2000	2500	3200								
Rated insulation voltage(Ui)	690V												800V																
Rated concussion withstand voltage(Uimp)	8KV																												
Rated working voltage(Ue)	AC400V																												
Rated working current (Ie)	16	20	25	32	40	50	63	80	100	125	160	250	400	630	800	1000	1250	1600	2000	2500	3200								
Using category	AC-33B												AC-33iB																
Rated short-circuit connection capacity	8KA							26KA			67KA																		
Rated short-time withstand current(Icw)	5kA/30ms							12.6kA/60ms			32kA/60ms																		
Transfer time I-II or II-I	2.5s							0.6s			1.2s			1.8s			2.4s												
Control voltage	DC24V、48V、110V、AC220V																												
Rated frequency	Start	20W							325W			355W			400W			440W			600W								
	Normal	20W							62W			74W			90W			98W			120W								
Weight(kg) 4Pole	3.4							6.0		7.6		15.8		16.8		36		36		37		38.6		55		61		67	

3. Switch structure explain

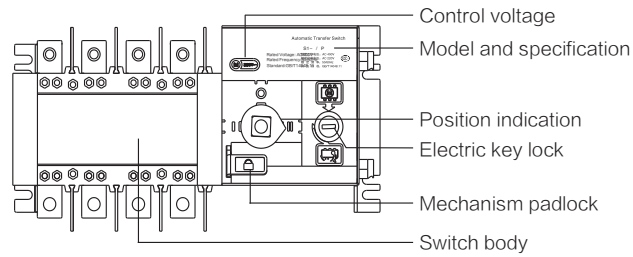

Picture 2

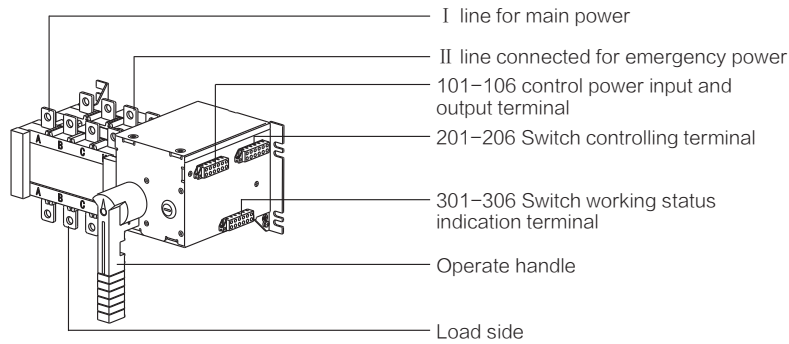

Picture 3

- ① Electric key lock: Control the inside controlling line power supply of the switch, when the Electric lock open, the switch could be operated automatically and remotely, when the electric lock closed, the switch could be operated by handle only.
- ② Operating handle: When operate the switch by the operating handle, the electric lock must be closed.
- ③ Mechanic padlock: When inspection, firstly turn the switch to the "0" position by operation handle, then pull the padlock mechanism and close the padlock, then the inspection can be arranged: (Pull the mechanism padlock will cut off the inside controlling power supply of the switch. The switch couldn't be in electric position and also couldn't be manual operation.
- ④ Position indication: It means the position of the switch working estate (I , 0, II)
- ⑤ Controlling voltage: AC220V

4. Outline and installation dimensions

□ 16A~1600A installation diagram (2 input 1 output)

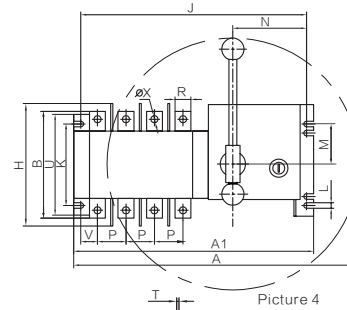

Picture 4

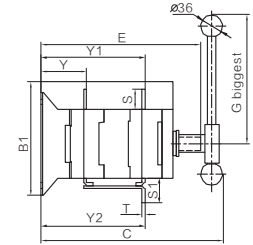

400A~1600A Picture 5

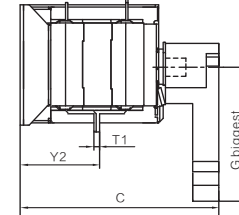

100A Picture 6

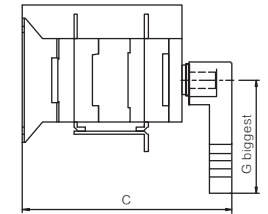

160A~250A Picture 7

□ 16A~1600A installation dimensions (2 input 1 output)

Specification	Total dimension							Switch installation											Connection terminal						
	A	A1	B	B1	C	E	G	H	J	K	L	M	N	P	R	S	S1	T	T1	U	V	φX	Y	Y1	Y2
16~100A	270	245	110	103	170	142	115	146	226	84	7	44	81	30	14	18	23	2.5	5	103	12	6	40.5	92	67.5
125~160A	348	305	147	142	224	190	144	185	284	102	7	49	91	36	20	25	37	3.5	/	127.5	19	9	56	127.5	127.5
250A	411	368	170	142	224	190	144	200	347	102	7	49	91	50	25	29	40	3.5	/	141.5	28	11	56	130	130
400A/3P	525	374	234	222	305	268	250	290	354	179	9	96	91	65	32	37	52	5	/	222	38	11	83	193	193
400A/4P	585	435	234	222	305	268	250	290	415	179	9	96	91	65	32	37	52	5	/	222	38	11	83	193	193
630A/3P	525	374	250	222	305	268	250	290	354	179	9	96	91	65	40	45	61	6	/	222	38	12	83.5	193.5	196
630A/4P	585	435	250	222	305	268	250	290	415	179	9	96	91	65	40	45	61	6	/	222	38	12	83.5	193.5	196
800~1000A/3P	785	520	328	250	390	326	360	/	496	220	11	115	84	120	60	64	88	8	/	250	56.5	13	109	254	254
800~1000A/4P	1080	635	328	250	390	326	540	/	610	220	11	115	84	120	60	64	88	8	/	250	60.5	13	109	254	254
1250A/3P	785	520	336	250	390	326	360	/	496	220	11	115	84	120	80	68	100	8	/	250	56.5	13	109	254	254
1250A/4P	1080	635	336	250	390	326	540	/	610	220	11	115	84	120	80	68	100	8	/	250	60.5	13	109	254	254
1600A/3P	785	520	336	250	390	326	360	/	496	220	11	115	84	120	80	68	108	10	/	250	56.5	13	110	255	255
1600A/4P	1080	635	336	250	390	326	540	/	610	220	11	115	84	120	80	68	108	10	/	250	60.5	13	110	255	255

□ 16A~1600A installation diagram (2 input 2 output)

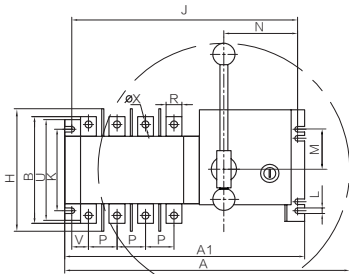

Picture 8

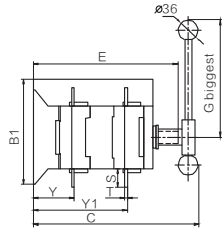

400A~1600A

Picture 9

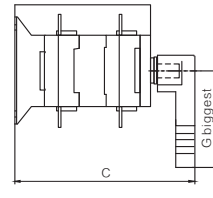

100A~250A

Picture 10

□ 1000A~1600A installation diagram

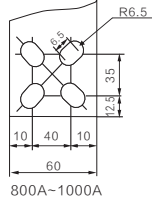

800A~1000A

Picture 11

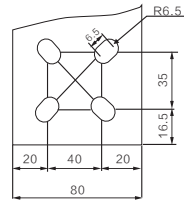

1250A~1600A

Picture 12

□ 16A~1600A installation dimensions (2 input 2 output)

Specification	Total dimension								Switch installation								Connection terminal					
	A	A1	B	B1	C	E	G	H	J	K	L	M	N	P	R	S	T	U	V	φX	Y	Y1
16~100A	270	245	106	103	170	142	115	146	226	84	7	44	81	30	14	18	2.5	103	12	6	40.5	92
125~160A	348	305	135	142	224	190	144	185	284	102	7	49	91	36	20	25	3.5	127.5	19	9	56	127.5
250A	411	368	159	142	224	190	144	200	347	102	7	49	91	50	25	29	3.5	141.5	28	11	56	130
400A/3P	525	374	234	222	305	268	250	290	354	179	9	96	91	65	32	37	5	222	38	11	83	193
400A/4P	585	434	234	222	305	268	250	290	414	179	9	96	91	65	32	37	5	222	38	11	83	193
630A/3P	525	374	250	222	305	268	250	290	354	179	9	96	91	65	40	45	6	222	38	12	83.5	193.5
630A/4P	585	434	250	222	305	268	250	290	414	179	9	96	91	65	40	45	6	222	38	12	83.5	193.5
800~1000A/3P	785	520	328	250	390	326	360	/	496	220	11	115	84	120	60	64	8	250	56.5	13	109	254
800~1000A/4P	1080	635	328	250	390	326	540	/	610	220	11	115	84	120	60	64	8	250	60.5	13	109	254
1250A/3P	785	520	336	250	390	326	360	/	496	220	11	115	84	120	80	68	8	250	56.5	13	109	254
1250A/4P	1080	635	336	250	390	326	540	/	610	220	11	115	84	120	80	68	8	250	60.5	13	109	254
1600A/3P	785	520	336	250	390	326	360	/	496	220	11	115	84	120	80	68	10	250	56.5	13	110	255
1600A/4P	1080	635	336	250	390	326	540	/	610	220	11	115	84	120	80	68	10	250	60.5	13	110	255

□ 2000A~3200A 2 input 1 output installation diagram

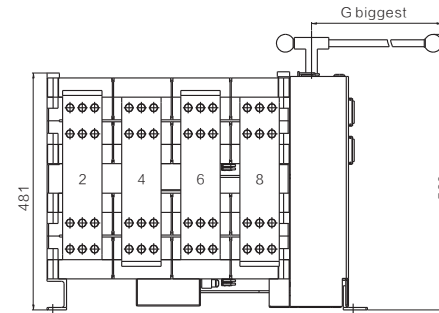

Picture 13

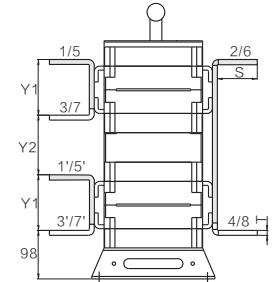

Picture 14

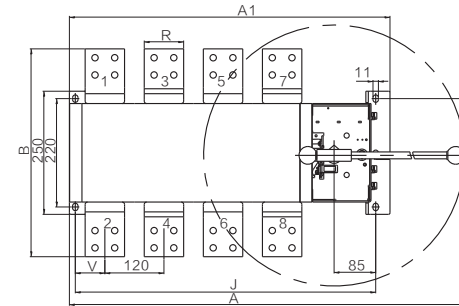

Picture 15

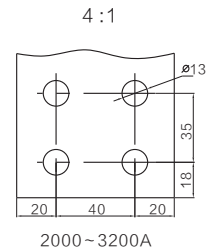

Picture 16

□ 2000A~3200A installing dimensions

Specification	A	A1	B	G	J	R	S	T	V	Y1	Y2
2000A/3P	785	537	423	360	496	80	81	10	56	113	121
2000A/4P	1080	651	423	540	610	80	81	10	72	113	121
2500A/3P	785	537	433	360	496	80	81	15	56	118	116
2500A/4P	1080	651	433	540	610	80	81	15	72	118	116
3200A/3P	785	537	443	360	496	80	81	20	56	123	111
3200A/4P	1080	651	443	540	610	80	81	20	72	123	111

5. Manual instruction

5.1: GA1 type Economic ATS manual instruction(Fit for rated current:16A-100A)

Note: Please pay attention to Main power and Emergency power phase sequence corresponding relation when you are wiring the switch.

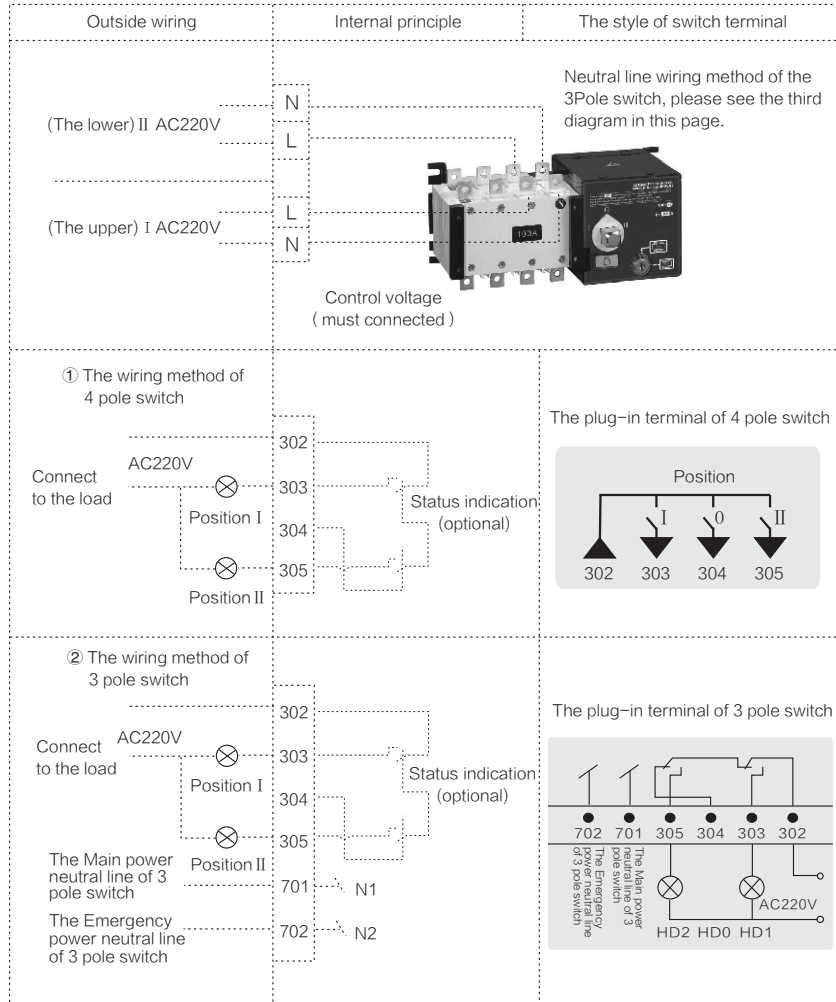

5.2 GA type fire type ATS manual instruction(Fit for rated current:16A-3200A)

Note: Please pay attention to Main power and Emergency power phase sequence corresponding relations when you are wiring the switch.

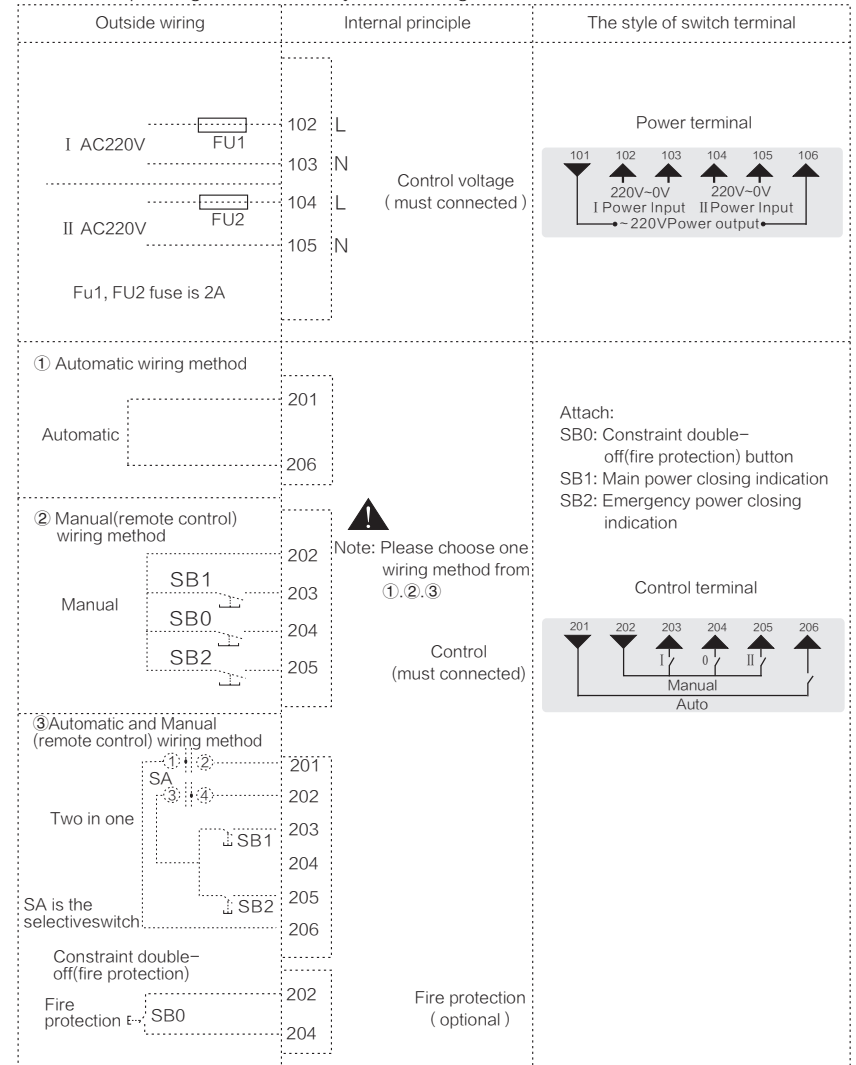

Outside wiring	Internal principle	The style of switch terminal
Start the generator signal	301 306 Start generator (optional)	
<p>▲Warning: Could not connect together with external wire.</p> <p>Closing indication</p> <p>Position I</p> <p>Position 0</p> <p>Position II</p>	<p>106 AC220V power supply internal output</p> <p>101</p> <p>302 Status indication (optional)</p> <p>303</p> <p>304</p> <p>305</p> <p>306</p>	<p>Status indication terminal</p>
Position I	402 403 Position auxiliary (optional)	<p>Position auxiliary terminal (passive)</p> <p>PREBRAK</p> <p>401 PRE I 403 PRE II 405</p> <p>Above 400A switch with it</p>
Position II	404 405	
Auto /Manual	502 503 Indicate Auto/Manual working manner and padlock (optional)	<p>The key and padlock auxiliary terminal (passive)</p> <p>MANU-PADLOCK</p> <p>501 502 503 504 505 506</p> <p>Above 400A switch with it</p>
Padlock	504 505	

5.3 GA type ATS using manual (Fit for 16A-3200A fission type)

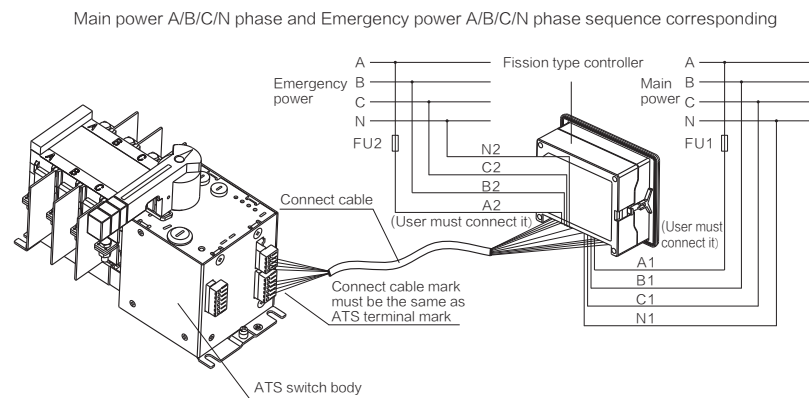

Picture 17

Note: Controller manual instruction please to see the Y-701/702 user manual

6.Method of terminal connection

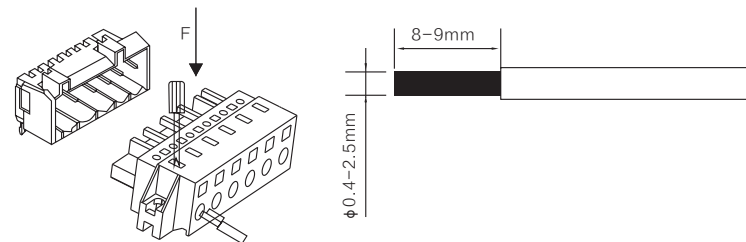

Use the screw driver use force downwards as the picture indicated direction,the line imbedding as the picture shows.

Picture 18

7. Correct installation method of the switch

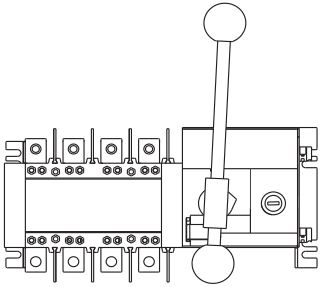

Picture 19

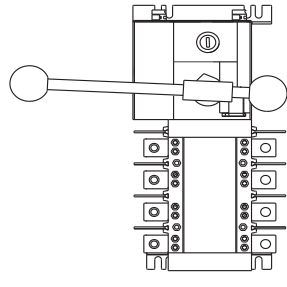

Picture 20

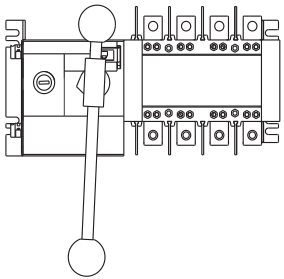

Picture 21

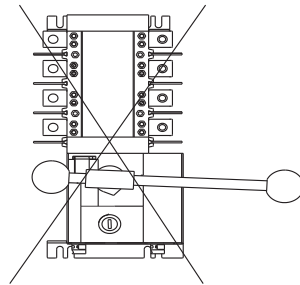

Picture 22

19, 20, 21 is correct, 22 is incorrect

8. Wiring methods of the switch

- 8.1 The primary wiring diagram to see the picture 3.
- 8.2 The control power is derived from normal power , emergency power cand N phases.
- 8.3 I and II line control power AC220V connected with terminal 102~103,104~105 respectively,102 and 104 are normal power and emergency power live line respective.
- 8.4 Terminal 101,106 are act as signal lamp to control the power supply.
Note:101 and 106 couldn't be connected with any other lines.
- 8.5 When above(under) input line, under(above)terminal I and II line A,B,C phases will be connected with copper lines or lines acting as output.

9. The instruction of debug the switch

9.1 Connect the normal power(I),emergency power(II) to the corresponding copper bar respectively;

① Automatic debugging

Normal power supply with electric,emergency power supply with Electric,switch I line switch on
Normal power supply without electric,emergency power supply with electric,switch II switch on
Normal power supply with electric,switch I line switch on
(Refer to the switch panel white indicating arrowhead)

② Remote debugging

Press the bush button SB1,then the switch I line switch on
Press bush button SB2,then the switch II line switch on

③ Automatic/Remote(Manual)debugging

When dial the function selection switch to the automatic position: the switch should act as the ① item required

When dial the function selection switch to the remote (manual) position, the switch should act as the ② item required

9.2 When the switch is in the position of switch on I line or II line,the signal lamp on the panel should indicate correspondingly;

9.3 After finished the debugging,close the power supply firstly,and transfer the switch to the "0" position by handle.(Middle position,refer to the switch panel white indicating arrowhead).